



# ABRITES DIAGNOSTICS FOR BIKES, SNOWMOBILES

and Water Scooters

**User manual**  
version 4.3



## Important notes

---

The Abrites software and hardware products are developed, designed and manufactured by Abrites Ltd. During the production process we comply to all safety and quality regulations and standards, aiming at highest production quality. The Abrites hardware and software products are designed to build a coherent ecosystem, which effectively solves a wide range of vehicle-related tasks, such as:

- Diagnostic scanning;
- Key programming;
- Module replacement,
- ECU programming;
- Configuration and coding.

All software and hardware products by Abrites Ltd. are copyrighted. Permission is granted to copy Abrites software files for your own back-up purposes only. Should you wish to copy this manual or parts of it, you are granted permission only in case it is used with Abrites products, has "Abrites Ltd." written on all copies, and is used for actions that comply to respective local law and regulations.

## Warranty

---

You, as a purchaser of Abrites hardware products, are entitled of a two-year warranty. If the hardware product you have purchased has been properly connected, and used according to its respective instructions, it should function correctly. In case the product does not function as expected, you are able to claim warranty within the stated terms. Abrites Ltd. is entitled to require evidence of the defect or malfunction, upon which the decision to repair or substitute the product shall be made.

There are certain conditions, upon which the warranty cannot be applied. The warranty shall not apply to damages and defects caused by natural disaster, misuse, improper use, unusual use, negligence, failure to observe the instructions for use issued by Abrites, modifications of the device, repair works performed by unauthorized persons. For example, when the damage of the hardware has occurred due to incompatible electricity supply, mechanical or water damage, as well as fire, flood or thunder storm, the warranty does not apply.

Each warranty claim is inspected individually by our team and the decision is based upon thorough case consideration.

Read the full hardware warranty terms on our [website](#)

## Copyright information

---

### Copyright:

- All material herein is Copyrighted ©2005-2021 Abrites, Ltd.
- Abrites software, hardware, and firmware are also copyrighted
- Users are given permission to copy any part of this manual provided that the copy is used with Abrites products and the “Copyright © Abrites, Ltd.” statement remains on all copies
- “Abrites” as used in this manual synonymous with “Abrites, Ltd.” And all it’s affiliates
- The “Abrites” logo is a registered trademark of Abrites, Ltd.

### Notices:

- The information contained in this document is subject to change without prior notice. Abrites shall not be held liable for technical/editorial errors, or omissions herein.
- Warranties for Abrites products and services are set forth in the express written warranty statements accompanying the product. Nothing herein should be construed as constituting any additional warranty.
- Abrites assumes no responsibility for any damage resulting from the use, misuse, or negligent use of the hardware or any software application.

## Safety information

---

The Abrites products are to be used by trained and experienced users in diagnostics and reprogramming of vehicles and equipment. The user is assumed to have a good understanding of vehicle electronic systems, as well as potential hazards while working around vehicles. There are numerous safety situations that cannot be foreseen, thus we recommend that the user read and follow all safety messages in the available manual, on all equipment they use, including vehicle manuals, as well as internal shop documents and operating procedures.

Some important points:

Block all wheels of the vehicle when testing. Be cautious when working around electricity.

- Do not ignore the risk of shock from vehicle and building-level voltages.
- Do not smoke, or allow sparks/flame near any part of the vehicle fuel system or batteries.
- Always work in an adequately ventilated area, vehicle exhaust fumes should be directed towards the exit of the shop.
- Do not use this product where fuel, fuel vapours, or other combustibles could ignite.

In case any technical difficulties occur, please contact the

**Abrites Support Team by email at [support@abrites.com](mailto:support@abrites.com)**

# Table of contents

I. Introduction .....	6
II. Vehicle diagnostics with the Abrites Diagnostics for Bikes, Snowmobiles and Water Scooters .....	9
1. Standard diagnostic functions .....	9
2. Advanced Diagnostics .....	14
III. Connecting your AVDI to various Bikes, Snowmobiles and Water Scooters .....	20
IV. List of supported models .....	28
V. Troubleshooting steps .....	28
1. Connection issues .....	28
2. Log files .....	30
VI. Additional cables .....	31
VII. Appendix .....	35
BMW R1200GS and other CAS4 late model BMW CAS PINs .....	35
Harley-Davidson key programming procedure .....	36

## List of revisions

---

Date	Chapter	Description	Revision
19.03.2014	ALL	First version of the document.	1.0
23.04.2014	ALL	Update and revision of the document	2.0
10.11.2014	ALL	Update and revision of the document	3.0
30.11.2015	Cables	Update to complete with new additions	4.1
26.10.2016	Appendix	BMW pinout	4.2
22.07.2021	ALL	Update and revision of the document	4.3
22.07.2021	Appendix	Harley-Davidson key programming procedure	4.3

## I. Introduction

---

The Abrites Diagnostics for Bikes, Snowmobiles and Water Scooters is a professional diagnostic software designed to work with the Abrites Vehicle Diagnostics Interface produced by Abrites Ltd.

The Abrites Diagnostics for Bikes, Snowmobiles and Water Scooters allows complete dealer level diagnostic operations for multiple brands and categories of motorcycles, snowmobiles, ATVs, UTVs and water scooters via their on board diagnostic (OBD) connectors or through bench connection.

The diagnostics is being performed over the appropriate communication protocol for each model.

As well as the standard diagnostic functions such as reading and clearing DTCs, module identification etc. the Abrites Diagnostics for Bikes, Snowmobiles and Water Scooters provides advanced diagnostic functions such as reading and updating configuration data of various modules installed on the vehicles, key learning functions for some models and others functions.

Getting started with the Abrites Diagnostics for Bikes, Snowmobiles and Water Scooters requires the users to perform the following:

- Double click the “Quick start” icon on the desktop and go to the motorcycle icon.
- Double click it and the Abrites Diagnostics for Bikes, Snowmobiles and Water Scooters will be started.

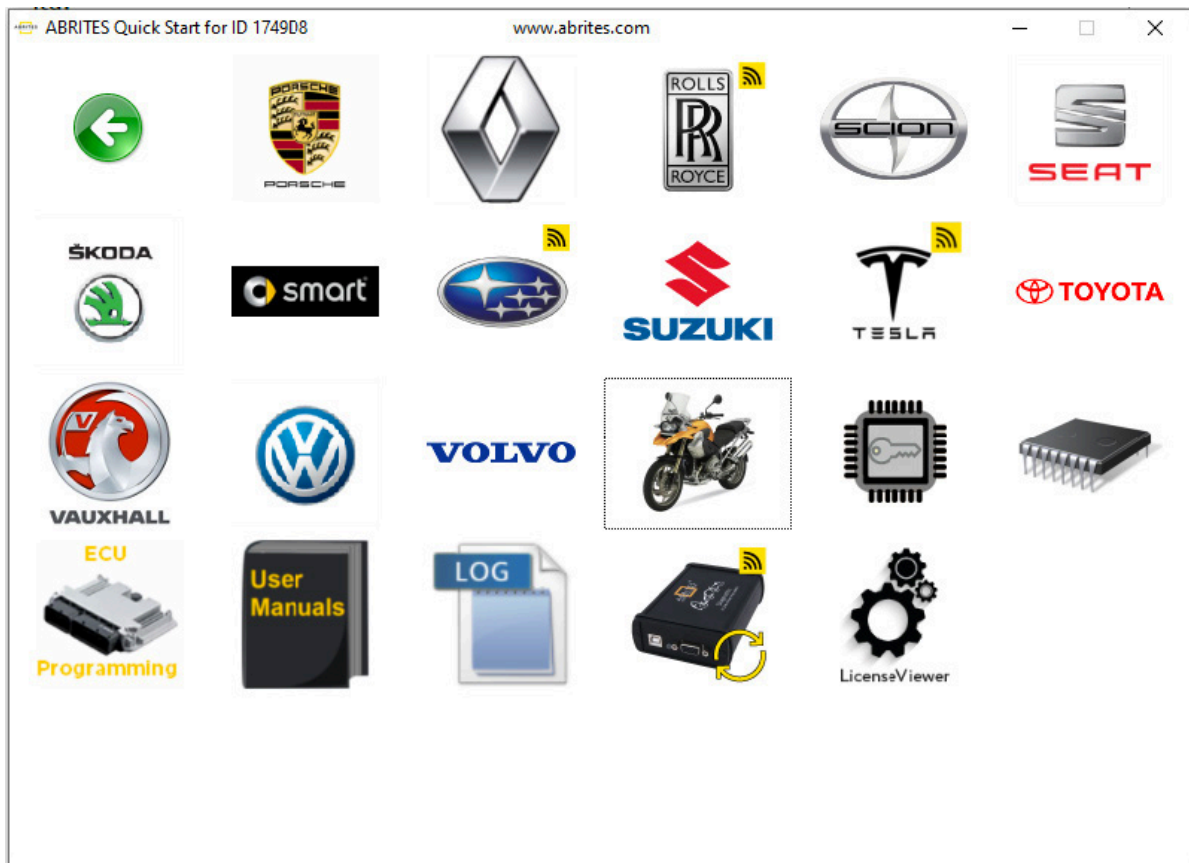

- Before using the Abrites Diagnostics for Bikes, Snowmobiles and Water Scooters please go to the “Options” menu and make sure that the “Debug logging” is enabled for troubleshooting purposes (described in section V), then select how long you would like for them to be kept on your computer. In the last drop down tab of the “Options” menu you can select the language that is most comfortable for you to use while working with the Abrites Diagnostics for Bikes, Snowmobiles and Water Scooters.

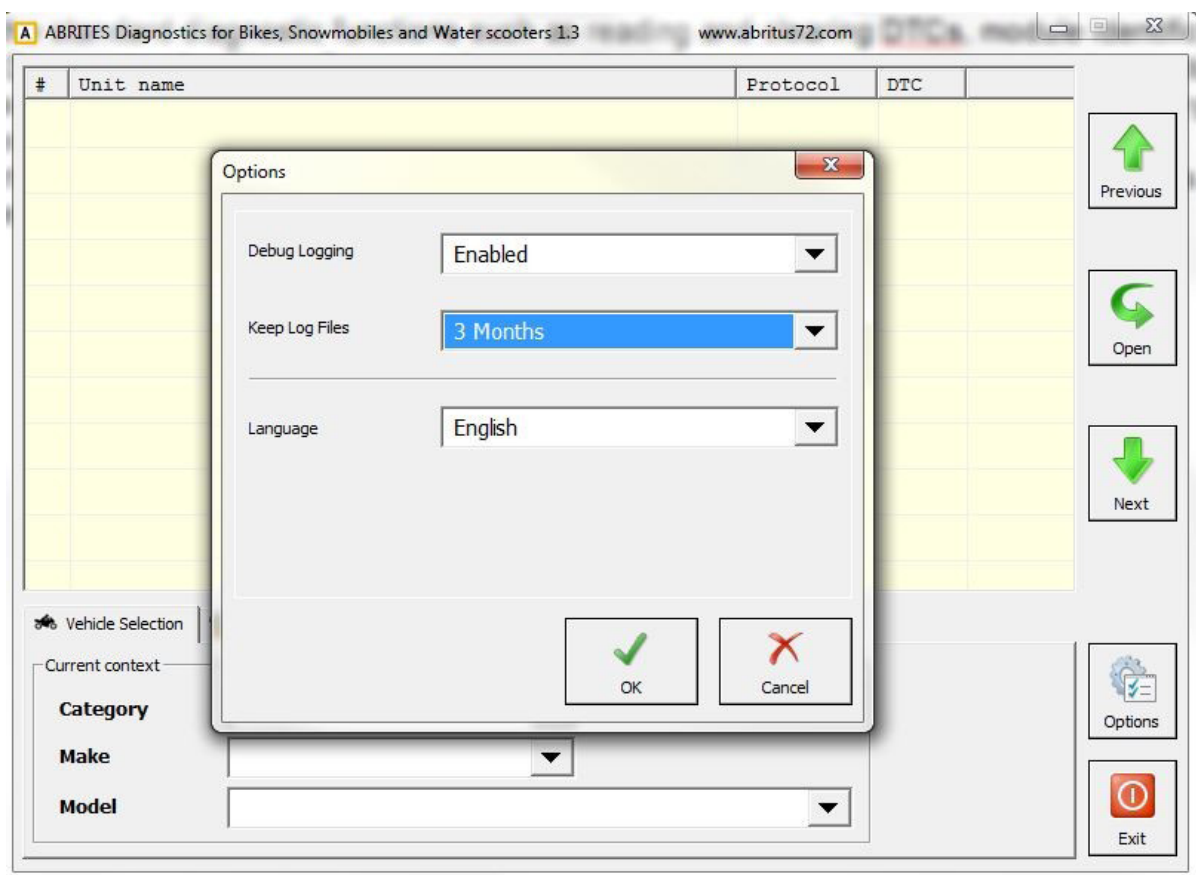



## II. Vehicle diagnostics with the Abrites Diagnostics for Bikes, Snowmobiles and Water Scooters

The Abrites Diagnostics for Bikes, Snowmobiles and Water Scooters software consists of basically two parts.

### 1. Standard diagnostic functions

Reading DTCs/ Clearing DTCs (fault codes)/ Scanning available modules and extended module identification, Data display in the supported vehicles.

When performing standard diagnostics the first step that needs to be performed is to select the type of vehicle that requires the diagnostic service. By default your first screen will be set to the “Vehicle selection” tab:

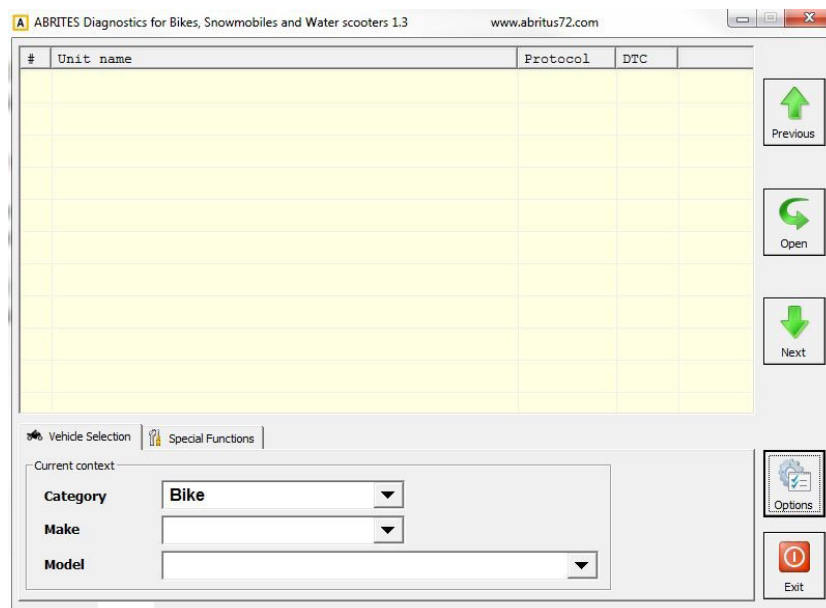

From this screen you will need to select the vehicle “Category” (e.g. Bike, Snowmobile, Water Scooter), the “Make” (e.g. Aprilia, BMW, Ducati, Harley-Davidson, Kawasaki, Gilera, Piaggio, Suzuki, etc.) and the “Model”.

*NOTE: For the purposes of the manual we are using a Suzuki motorcycle, the model is DL650K7-L2. This motorcycle has two electronic modules available. The principle is similar with any vehicle tested by the Abrites Diagnostics for Bikes, Snowmobiles and Water Scooters. The two available electronic modules of this motorcycle are **the Engine Control Unit** and **the Anti-lock Braking System**. In the “Protocol” field of the diagnostic screen we can determine that both units use the KWP protocol.*

- Select the vehicle as described above:

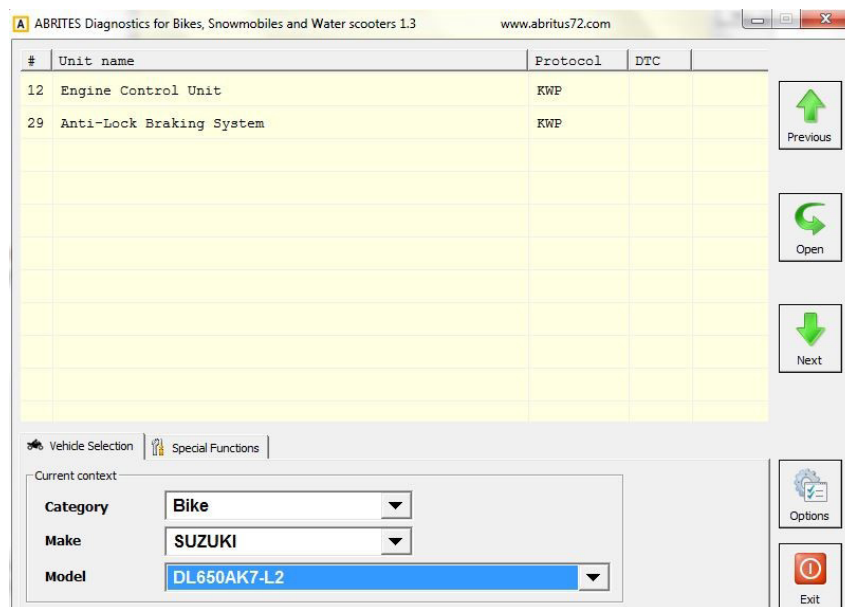

- Once the correct vehicle is selected the available electronic modules will be displayed in the “Unit name” field.
- Drill into the units in order perform diagnostics for them by double – clicking directly over the name of the unit:

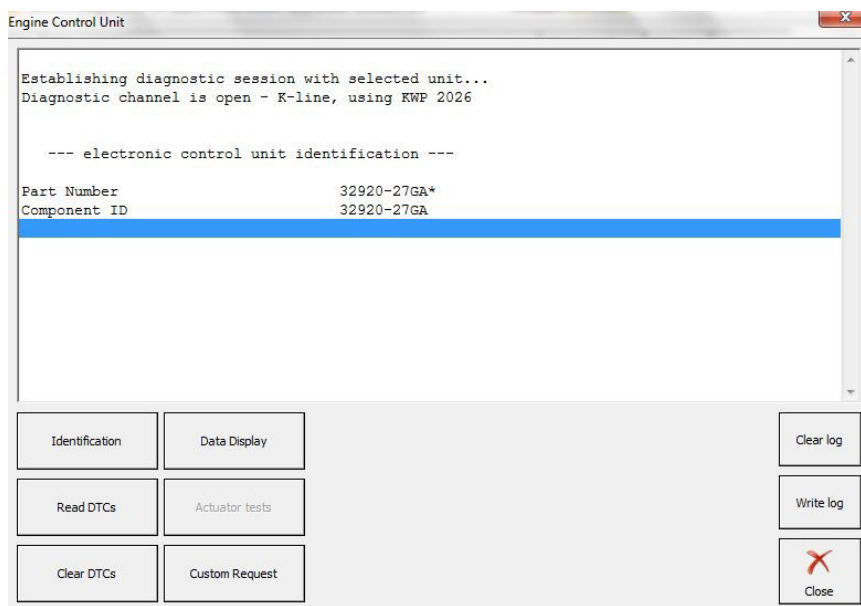

The display field will inform you about the establishment of a diagnostic session with the selected unit. It will also provide information about the protocol and on multiple occasions it will automatically display the unit identification in terms of Part number and Component ID.

- Selecting the “Identification” button will allow you to see the unit’s Part number and Component ID (This is mostly used for searching for replacement parts):

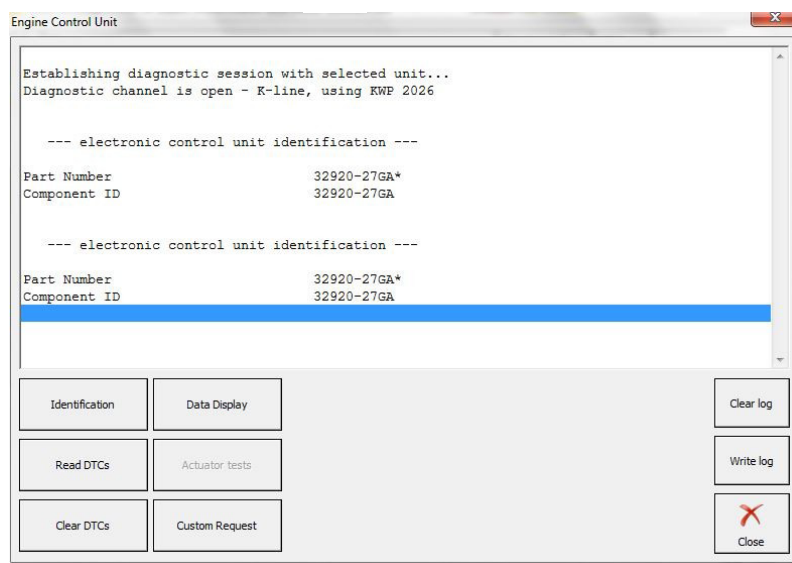

- Selecting the “Read DTC” button will read the Diagnostic Trouble Codes from the unit (if present), it will display it with the factory number of DTC as well as the appropriate text identification (if available):

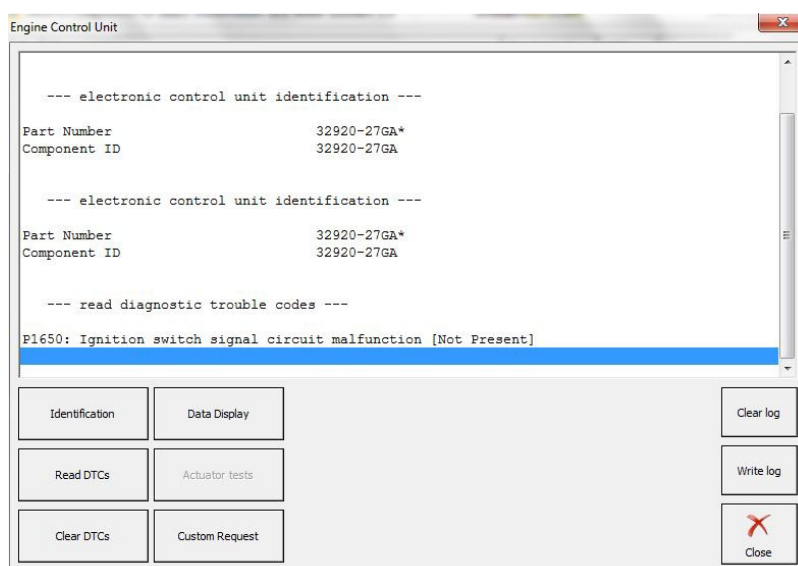

- Once the vehicle is repaired and the issue is removed the “Clear DTC” button is selected. This will remove the Diagnostic Trouble Code from the unit’s memory thus allowing the vehicle to operate correctly:

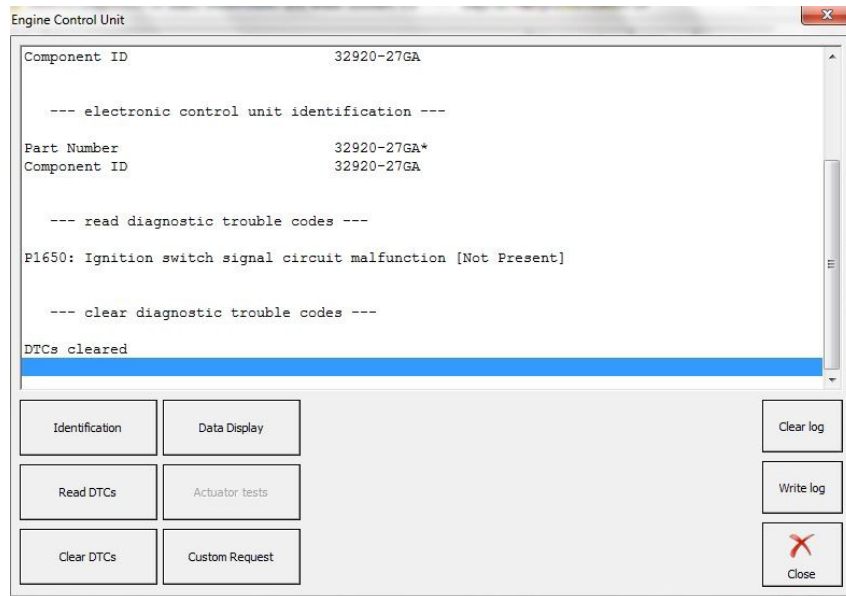

- The “Data Display” button provides a complete “actual value data” view of the vehicle in one, multiple or all parameters by gathering information from the vehicle’s sensors. This function is extremely helpful when determining a hidden fault within a vehicle or analyzing the “behavior” after specific modifications or repairs have been made:

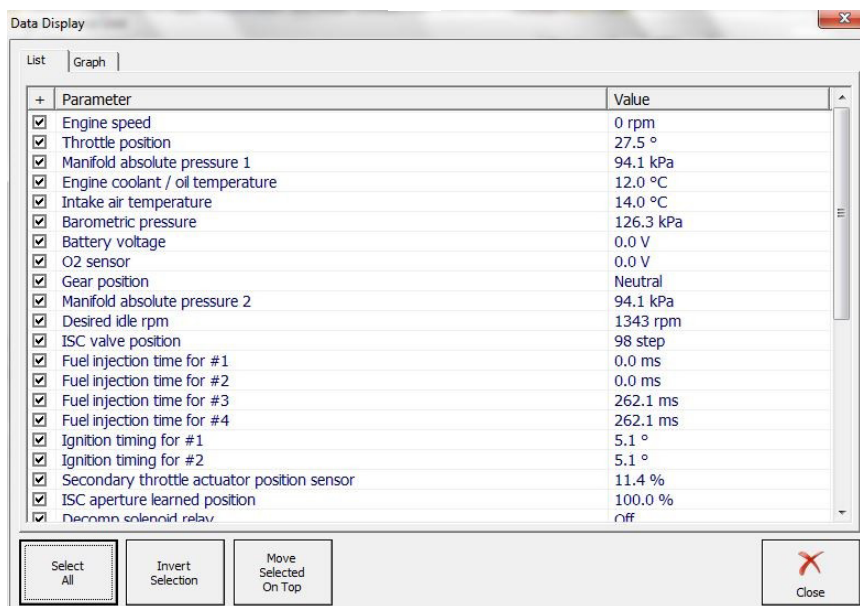

- The “Data Display” menu provides two different views. The “List” view, as shown above allows selection of sensors with a check box list. The list can be customized and its order can be modified by the user for a more accurate overview of the vehicle values. The “Graph” view allows the monitoring of a parameter in a graphic form in order to determine patterns and behavioral changes. It provides the available sensor signals in a drop down menu where a value can be selected:

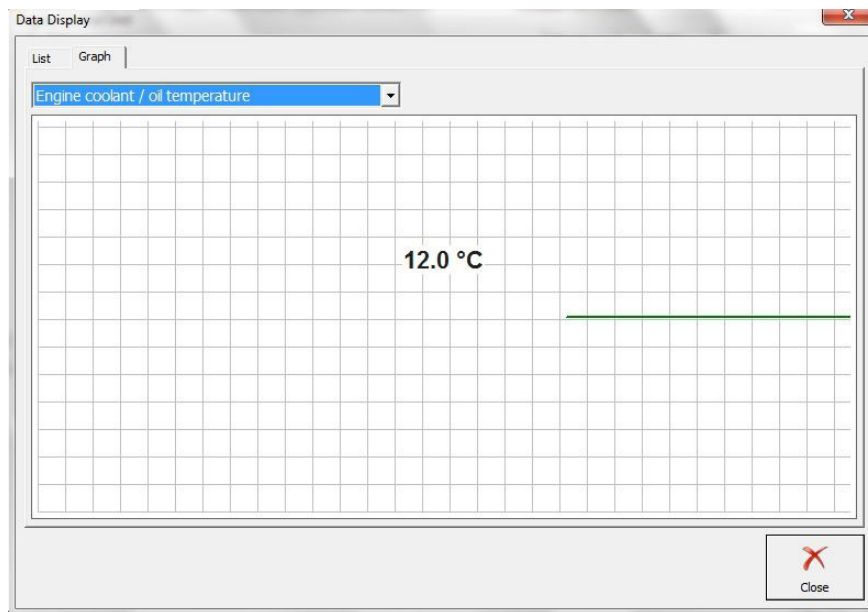

- “Custom Request” allows the user to send custom signals to the electronic units and monitor the response in a table view. The custom request can be saved for reference:

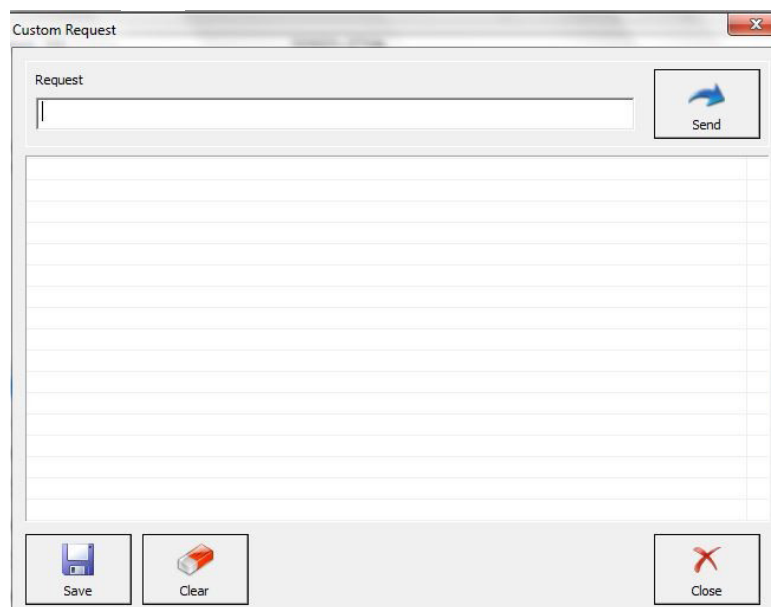

## 2. Advanced Diagnostics

The “Special functions” tab of the Abrites Diagnostics for Bikes, Snowmobiles and Water Scooters will provide you the options to perform “Advanced diagnostics” with the available vehicles:

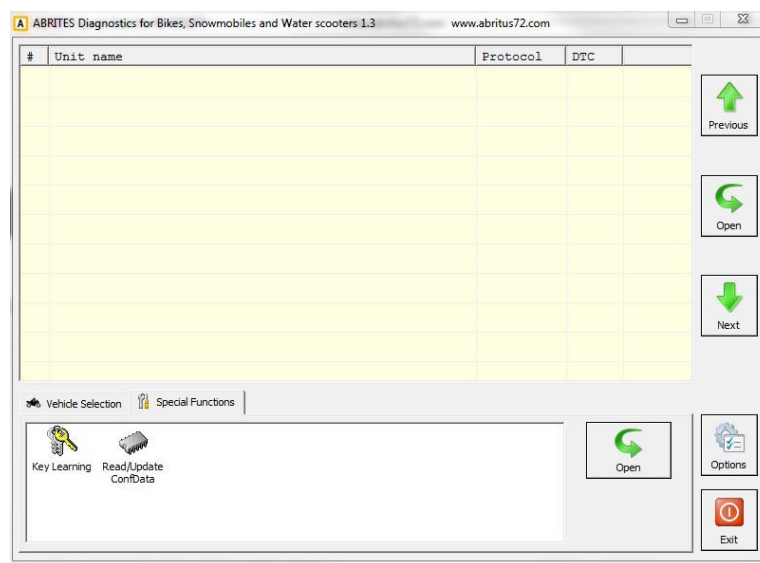

- The “Key learning” special function allows the user to prepare keys for the available vehicles in a simple “step – by – step” manner. Key learning is currently available for various Aprilia, BMW, BRP, Gilera, Harley-Davidson, Vespa and Piaggio models:

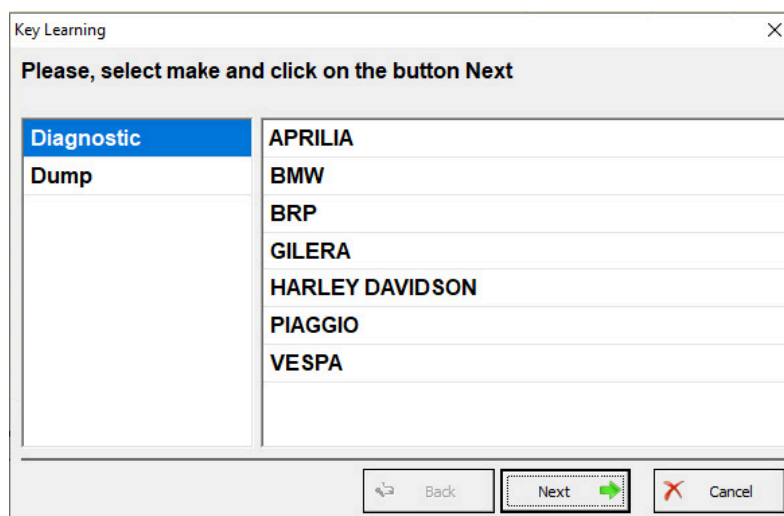

**Note:** Make sure to follow the instructions you see on the screen. Make sure to have your transponder programmer attached

- Programming a key with a Temic transponder requires the TAG key programmer to be connected to your AVDI. Once you have done that the Software will establish a connection to the unit and you will see the following screen:

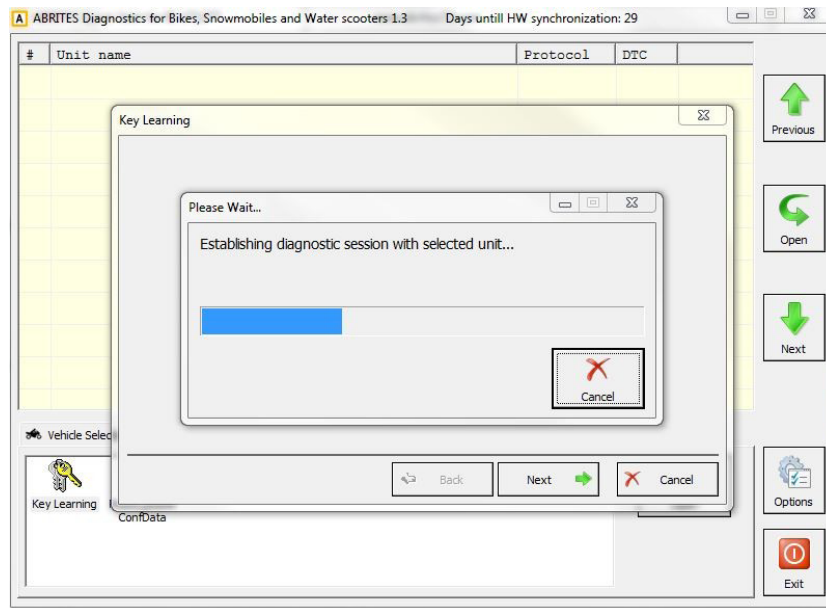

Once the connection to the unit is established you will be asked to select the key position and you should see the following screen:



Once that is done the software will ask you what programming operation you would like to perform. You can clone or replace the existing transponder by selecting the appropriate button:

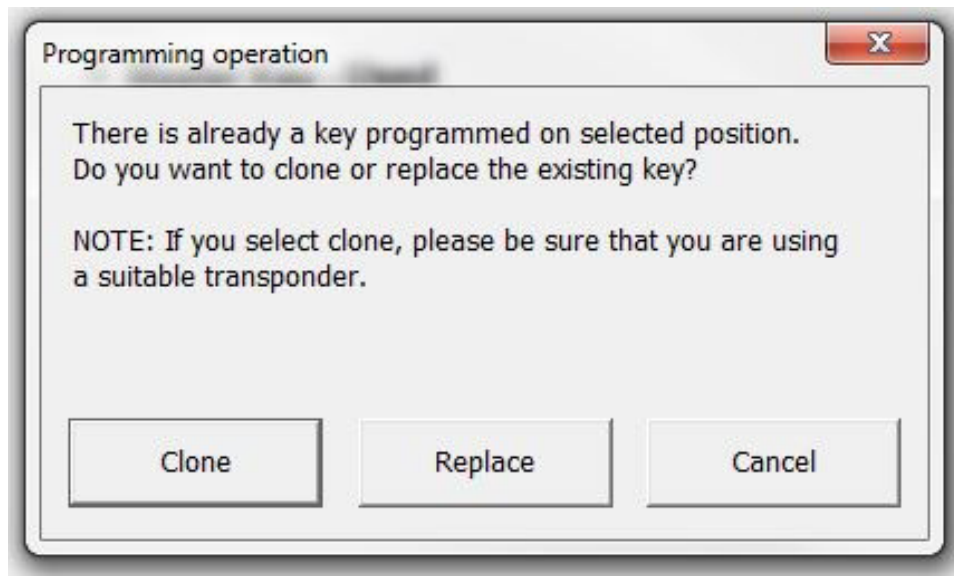

In this case we see that a master key is used and you should leave the position to its default. After clicking "Next" the software will inform you how to place the transponder within the key programmer antenna (aerial):

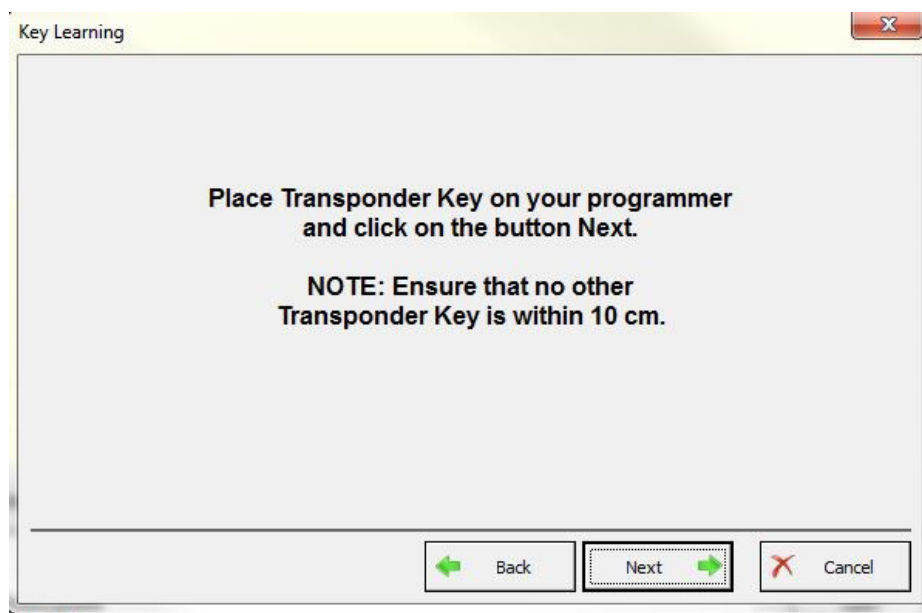



When you click next here you will need to wait a few seconds and the transponder will be ready for use.

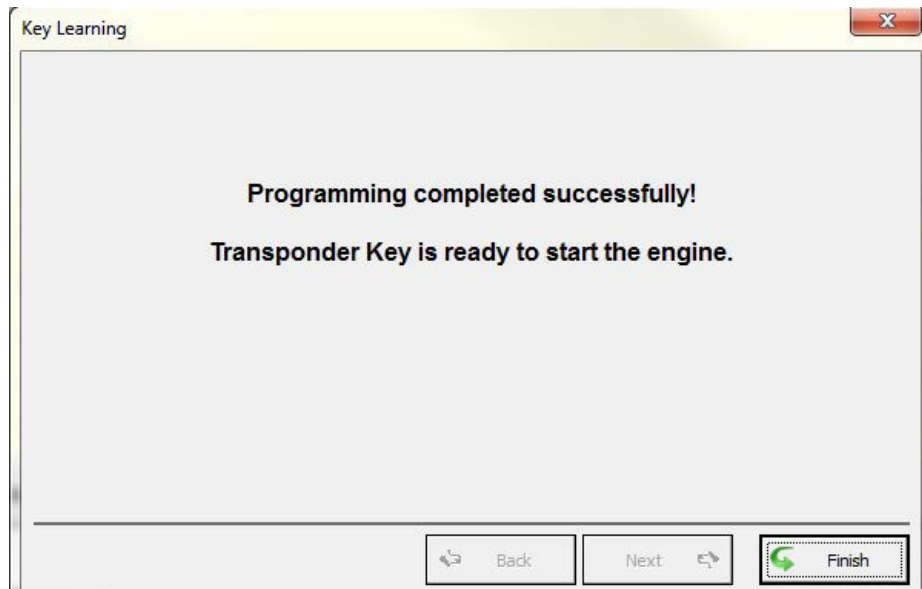

- Programming keys for BMW motorcycles.

In this case we are using a Hitag 2 transponder and a TAG transponder programmer. The first step is to connect the programmer and establish a diagnostic connection with the unit:

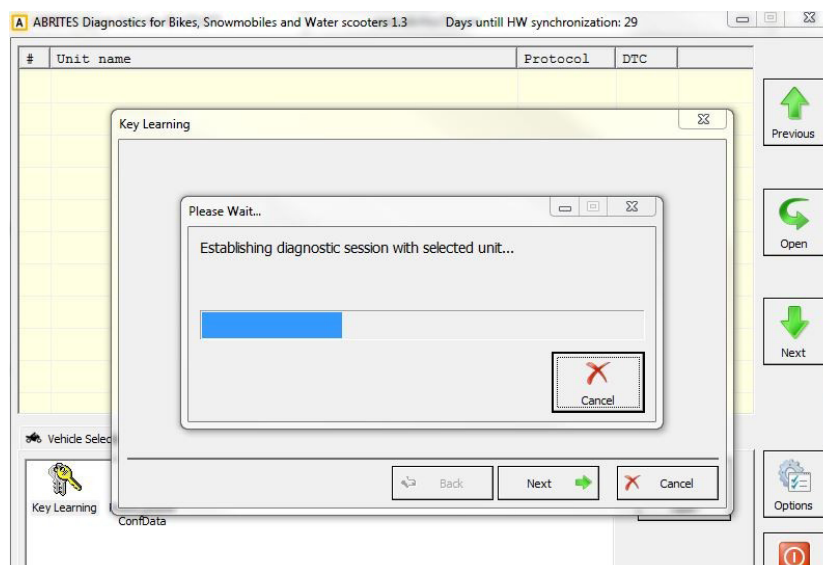

**Note:** Use the BMW online software for the latest BMW motorcycles with DST transponders.

The next step is to select the position where you would like to program the key:

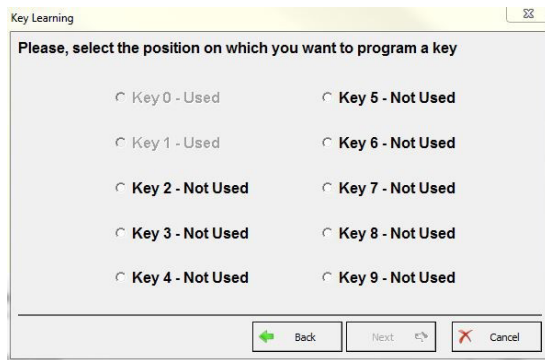

You should then follow the instructions on the programmer placement in the antenna:

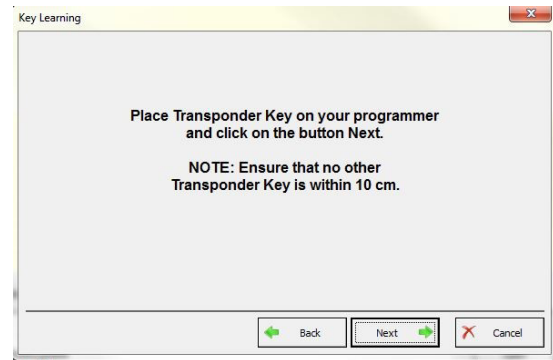

You will then be informed that the transponder is ready to start the engine:

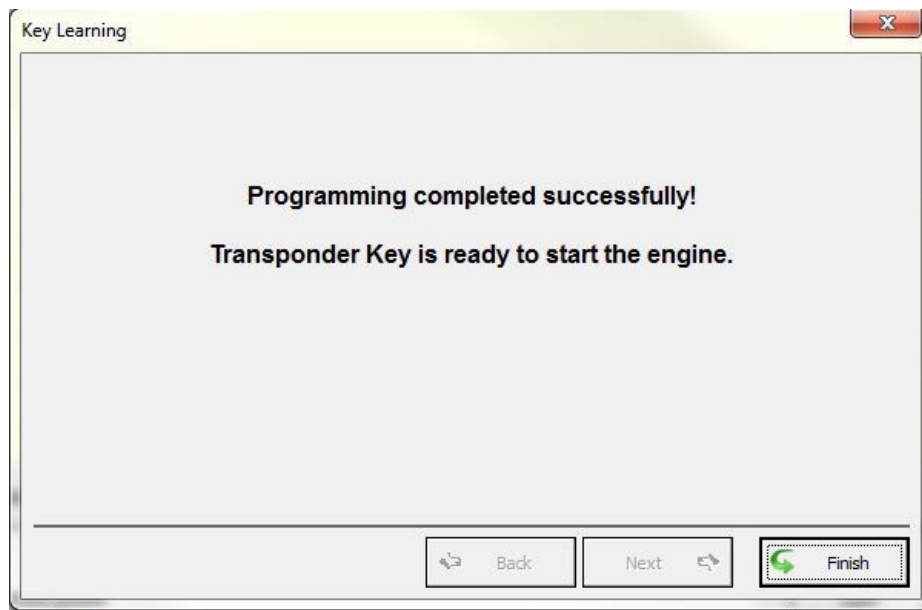

- “Read/ Update ConfData” allows the reading and updating of Configuration data from selected electronic control modules of various bikes, snowmobiles and water scooters. The “Read Confdata” button will read the Configuration data from the selected module, the “Update Confdata” will respectfully update the configuration data of the selected module. The selection is performed using a drop down menu within the “Read/ Update ConfData” special function menu. The “Load from file” button allows you to update the configuration data by loading it from a preselected file, saved prior the update. “Make Virgin” allows you to virginize the CONF DATA of the ECUs available for this action.

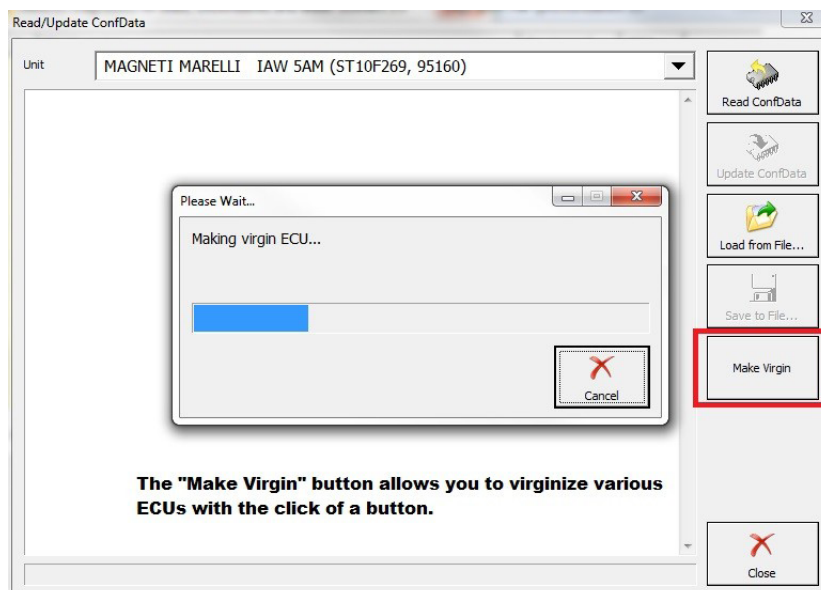
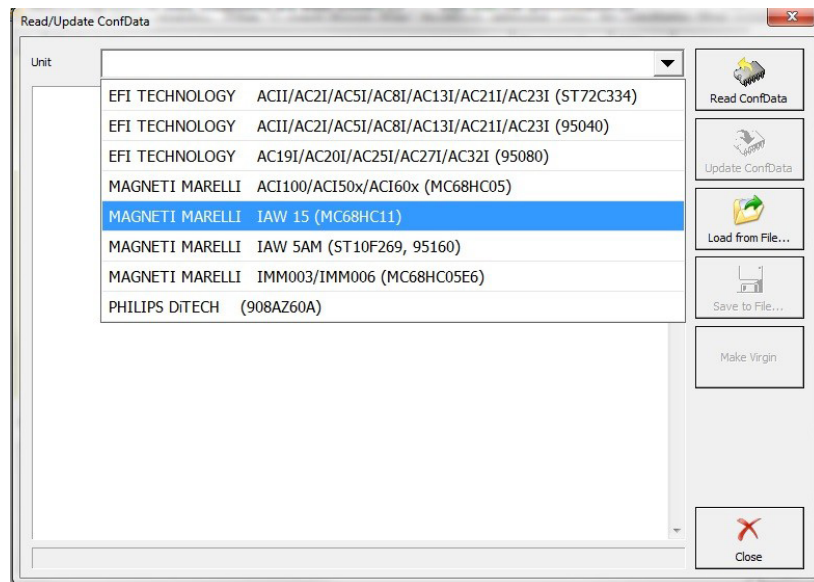

### III. Connecting your AVDI to various Bikes. Snowmobiles and Water Scooters

1. Unlike cars, where the standard for the diagnostic connection is unified under the OBDII connectors the motorcycles, snowmobiles and water scooters use a variety of connectors. The connection to the on board diagnostic connectors of these vehicles can be established in the following steps:

- **Determining the location of the diagnostic connectors.**

In the majority of cases the diagnostics connectors are located under the seat of the vehicle.

- **Determining the type of connectors required for the specific vehicle.**

Once the type of connector that is required for the vehicle in question is discovered the users can proceed to the next step.

- **“Translating” the signal from the On board diagnostic connector to the AVDI.**

2. In the photos below you can see various connector locations, types and connection cable pin outs.

- Suzuki motorcycles, quads, snowmobiles and water scooters most commonly have their 6 pin connector under the seat



In the photo above you can see it in white, it has a rubber waterproof cap which needs to be removed in order for the connector to be exposed.

The standard Suzuki six pin connector is depicted below:

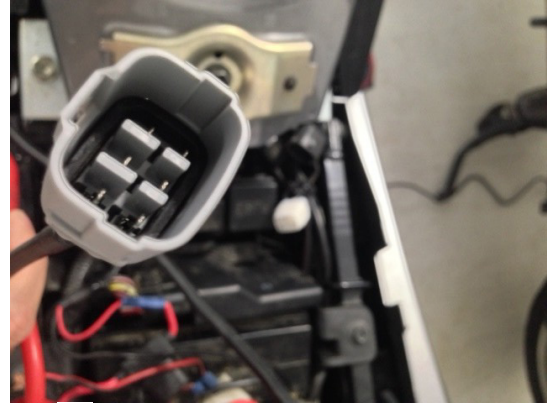

The pin out for the 6 pin connector is as shown here:

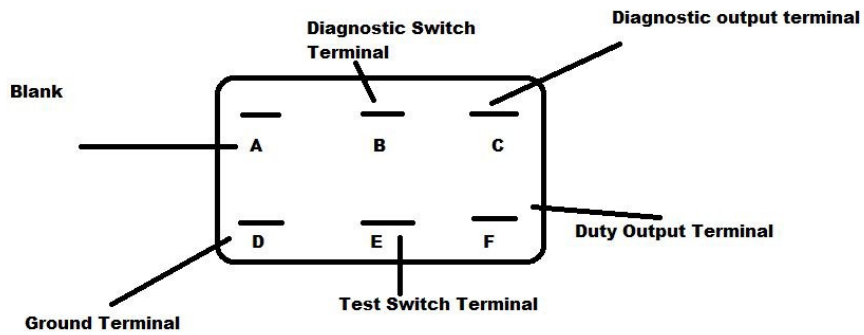

Here you can see the two connected on the vehicle:



The connection from the Suzuki vehicles to your AVDI is established by connecting the 6 pin connector to a DB9 connector and then to a DB25 connector in order for the signal to enter the DB25 connector on the AVDI via the following table:

DB9	DB9
PIN 1 - Ground	PIN 5- Ground
PIN 4 - K-line	PIN 8 - K - line
PIN 9 - 12V	PIN 17 - 12V

- BMW motorcycles use a 10 pin diagnostic connector. The connection to the OBD II is depicted:

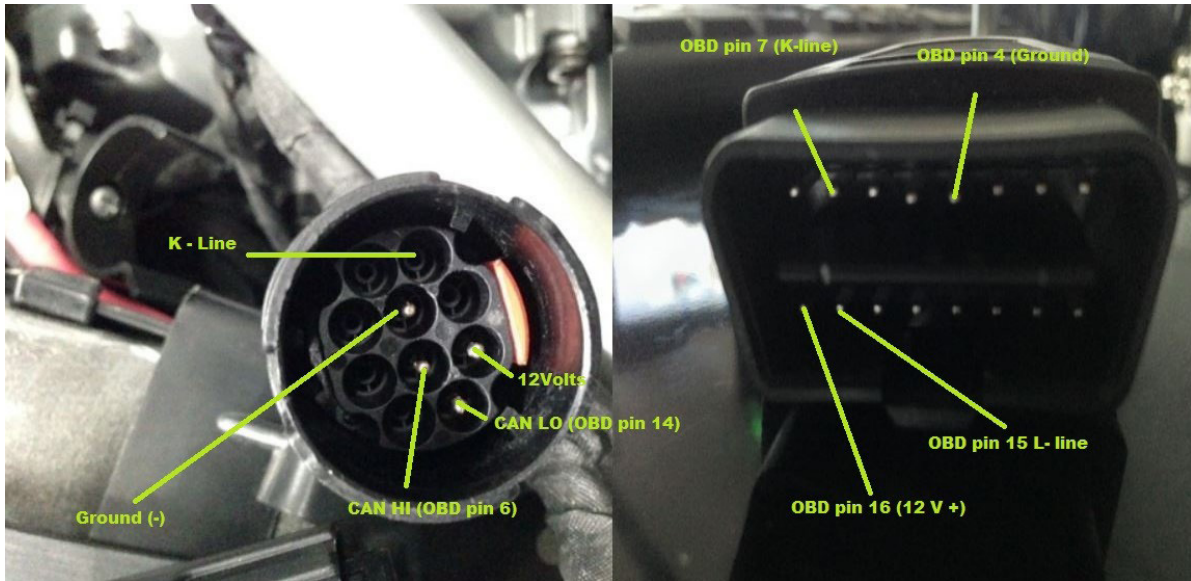

#### Location of the OBD for some of the most popular BMW models:

- S1000RR- under the rear seat cover
- R1200GS Adventure- under the rear portion of the seat
- R1200GS- under the seat
- R1200RT- under seat
- R1200C- under the left chrome cover
- HP2 Enduro- under the front of the seat, close to the tank
- K1200GT- under the rear of the seat
- K1200S- under the rear of the seat
- K1200LT- under the seat
- R1150 GS / Adventure- under the seat
- R1150RT- between rear light and seat
- G650X Challenge/Country/Moto- behind right front panel
- C1-200- behind the backrest of the seat

- Harley-Davidson motorcycles use a 4(old models) or 6 pin diagnostic connector. The connection to the OBD II is depicted:



Note: Older Harley-Davidson bikes that use a 4-PIN connector may need to communicate through the SAE J1850 protocols. This may require an Abrites J1850 adapter.



- Aprilia motorcycles 6 pin to OBDII connection depicted below:

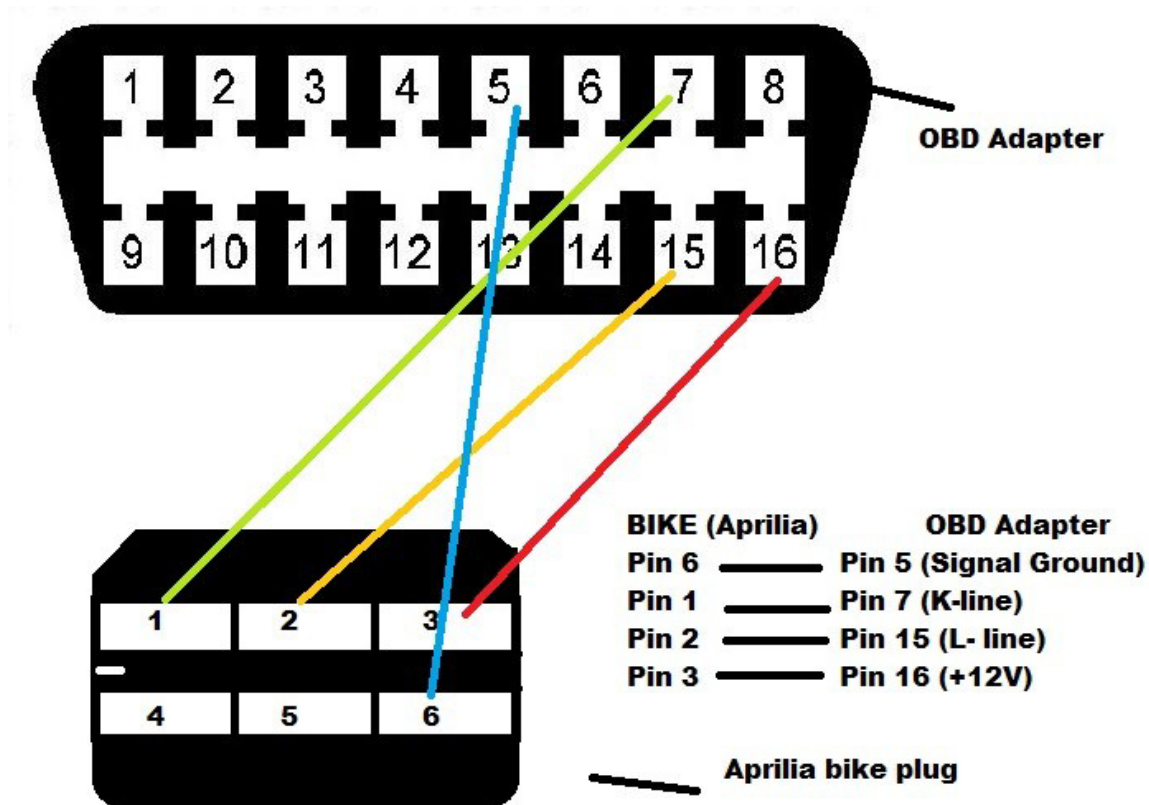

- Kawasaki vehicles, in most cases, have the diagnostic pin under the seat.

#### PINOUTS

For the following connections you will need to connect the modules using a DB9 connector. What you will need to remember is that the DB9 connector is structured in the following way:

PIN1 - GND  
 PIN4 - K-line  
 PIN9 - +12V

- Magneti Marelli ACI600.01

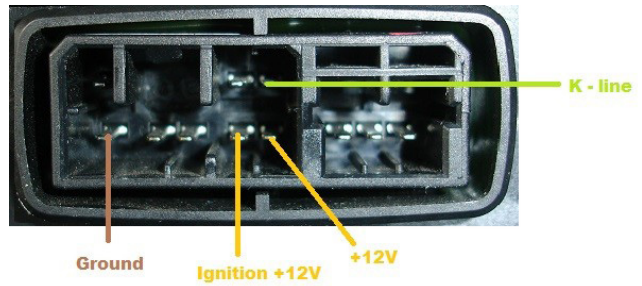

- Magneti Marelli IM006.04

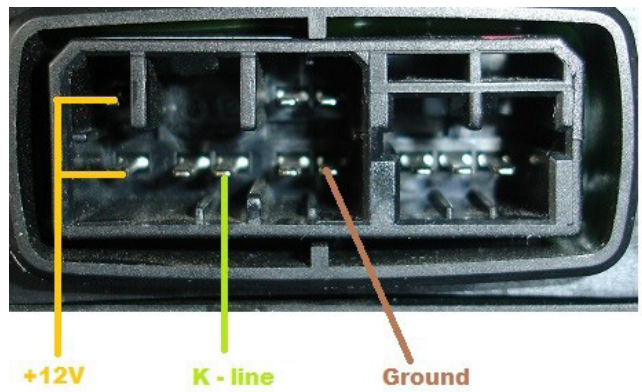

- Magneti Marelli IAW 5AM.GE BC.0098058.A

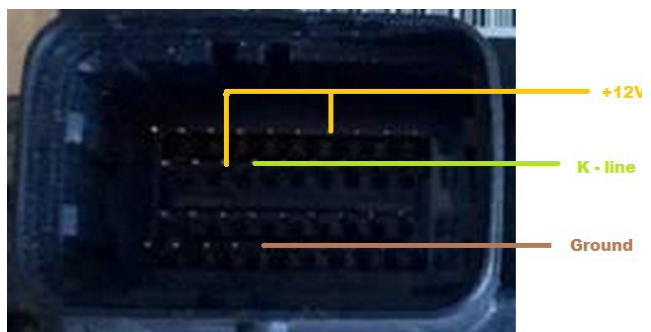

- EFI Technology 26-08 CM078307

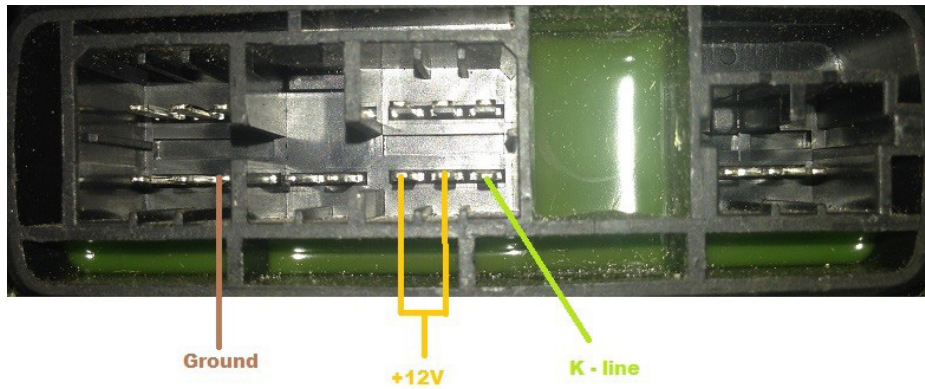

- EFI Technology 28-08 CM078311

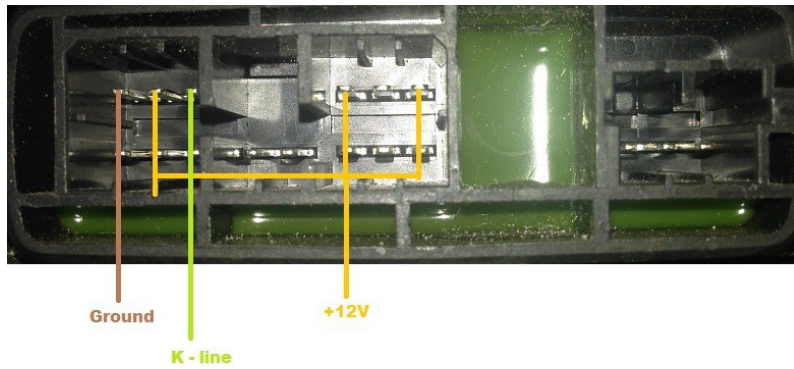

- Philips 325-024-0G 2 stroke DI

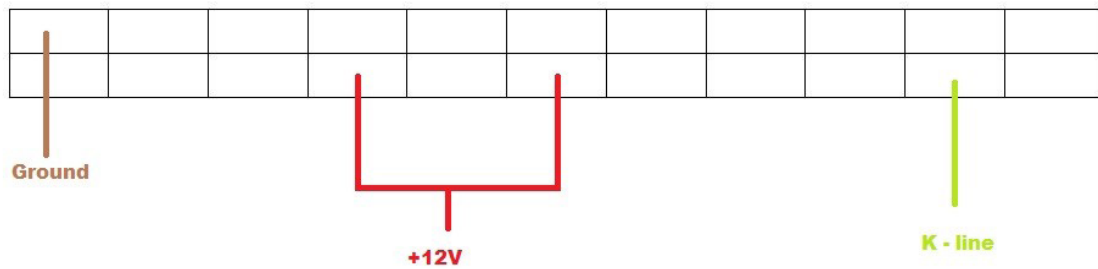

## IV. List of supported models

NOTE: Please be informed that module support may vary according to the model year. A full list of all supported models is available at [www.abrites.com](http://www.abrites.com)

## V. Troubleshooting steps

### 1. Connection issues

One of the most common faults that may occur with the Abrites Diagnostics for Bikes, Snowmobiles and Water Scooters is the impossibility of the software and interface to connect to the vehicle, subjected to diagnostics. In the example below the vehicle is defined and a module is being selected for diagnostics:

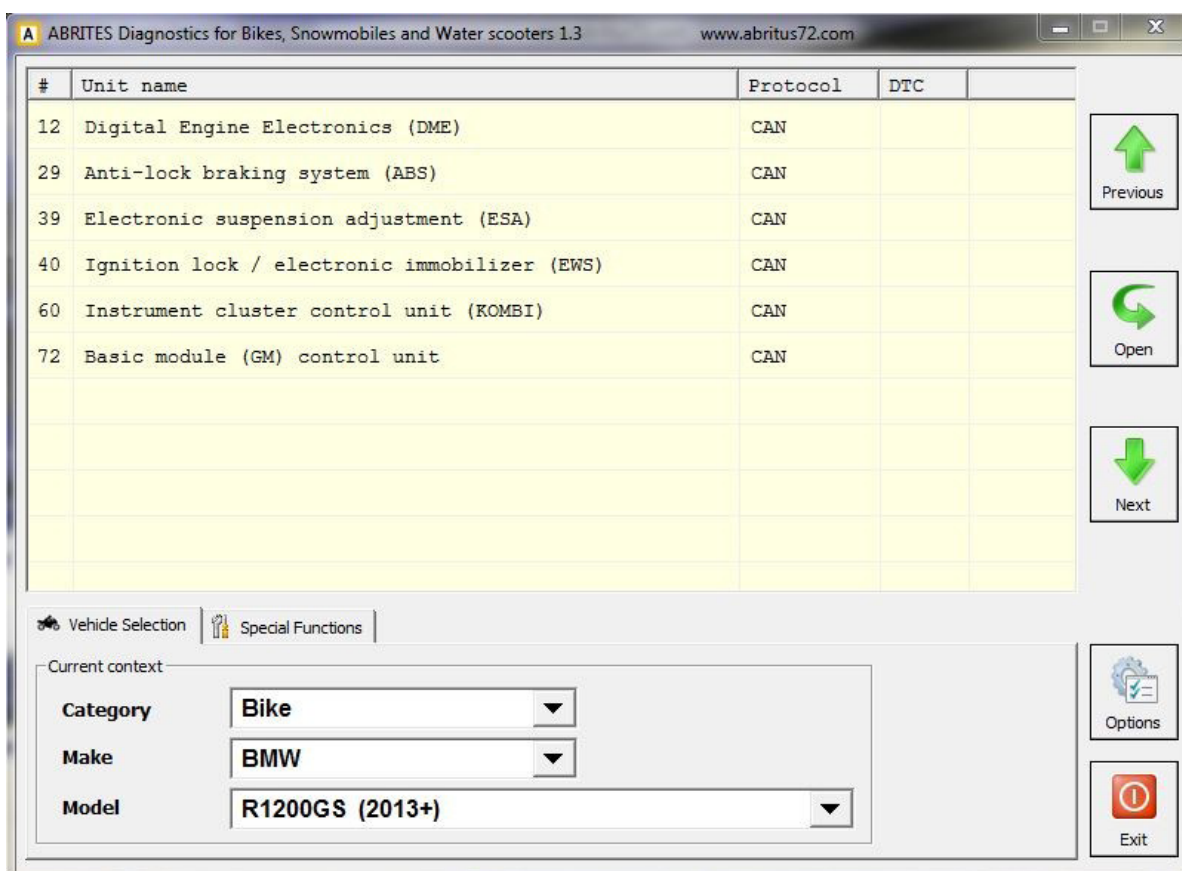

Once the Abrites Diagnostics for Bikes, Snowmobiles and Water Scooters attempts to establish a diagnostic connection, however, the following error message is displayed:

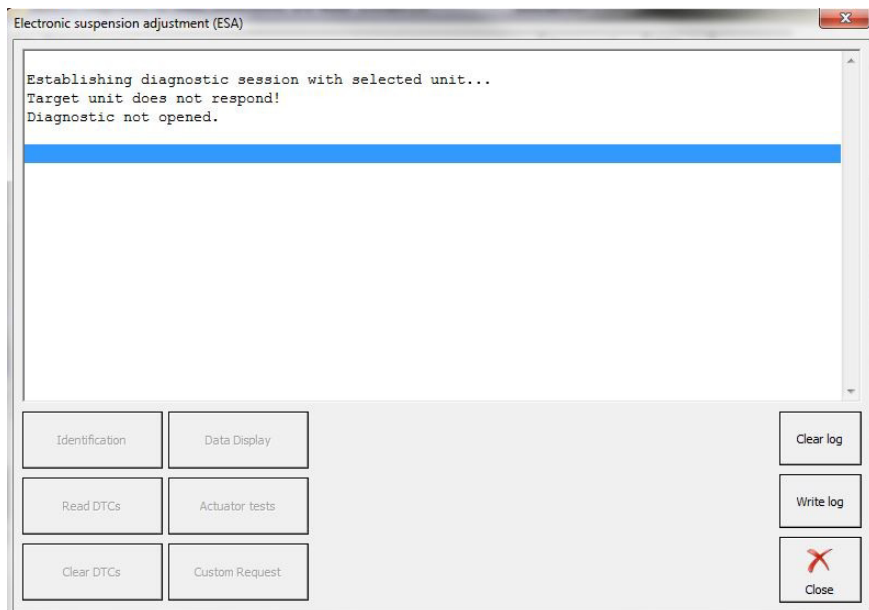

Other connection issues may occur when the transponder programmer is not connected to your AVDI during key learning. You will see the following error:

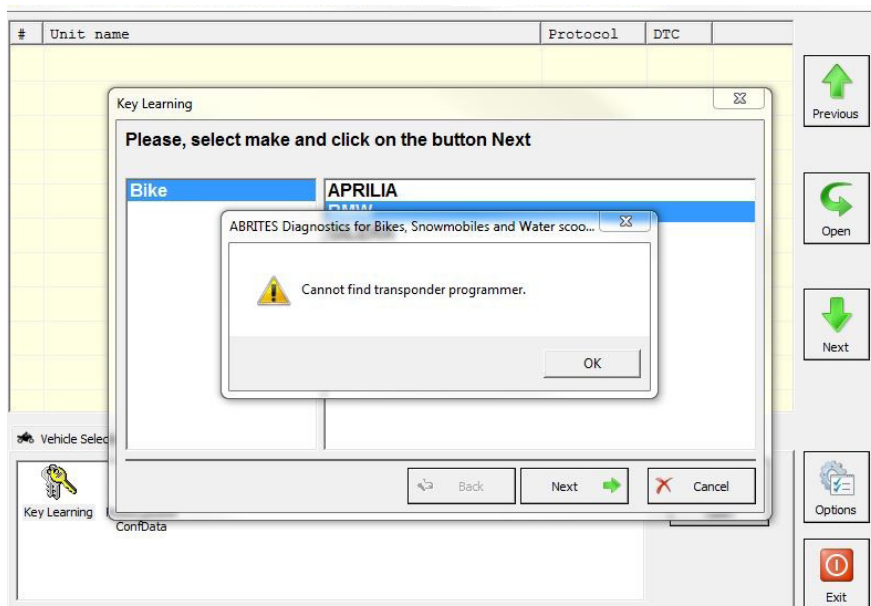

---

Possible causes for this issue may be:

- The AVDI is not connected to the user's computer.
- The diagnostic connector is inappropriately connected.
- The transponder programmer is not connected.

In both cases please make sure to check the connections or contact [support@abrites.com](mailto:support@abrites.com)

## 2. Log files

The log files are an essential part of the troubleshooting process. They are required to establish the root causes of issues, that have occurred unexpectedly. In most cases this is concerning the communication between the AVDI and the modules of the vehicle or the communication between the modules within the vehicle itself. Always make sure to attach the files from when the issue occurred to an e-mail sent to the support team. This will speed up the process of resolving an issue in case it is present. Please note that the log files can be located under: Start -> Programs -> ABRITES software for IDxxxxxx-> Log Files (where IDxxxxxx is your ADVI ID) or in the second page of the "Quick Start" menu under the "LOG" icon. In this directory you will see a list of folders. Please access the "BIKE" folder and copy the ".log" files from the time and date the issue occurred and attach them in your e-mail.

The log files icon in the "Quick Start" menu:



## VI. Additional cables

---

From the Abrites online store the users can purchase the following additional cables:

1. CB008 – Cable for AVDI cable for BMW bike diagnostic connector



2. CB301 - AVDI cable for connection with Aprilia Bikes



---

3. CB302 - AVDI cable for connection with KTM Bikes

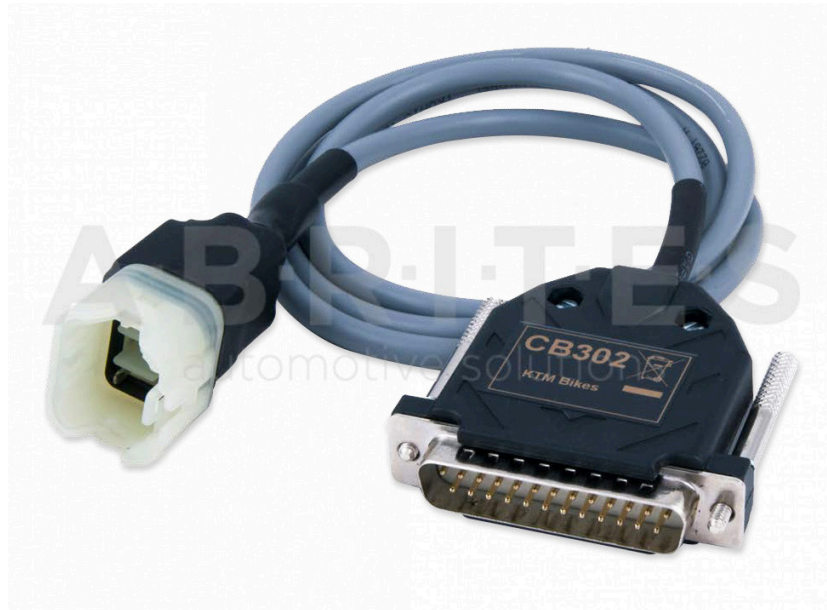

4. CB303 - AVDI cable for connection with Benelli Bikes





---

5. CB304 – AVDI cable for connection with Suzuki Bikes (6 pins)



6. CB305 – AVDI Cable for connection with Harley Davidson bikes (CAN/K-Line)



---

7. CB306 – AVDI Cable for connection with Piaggio bikes

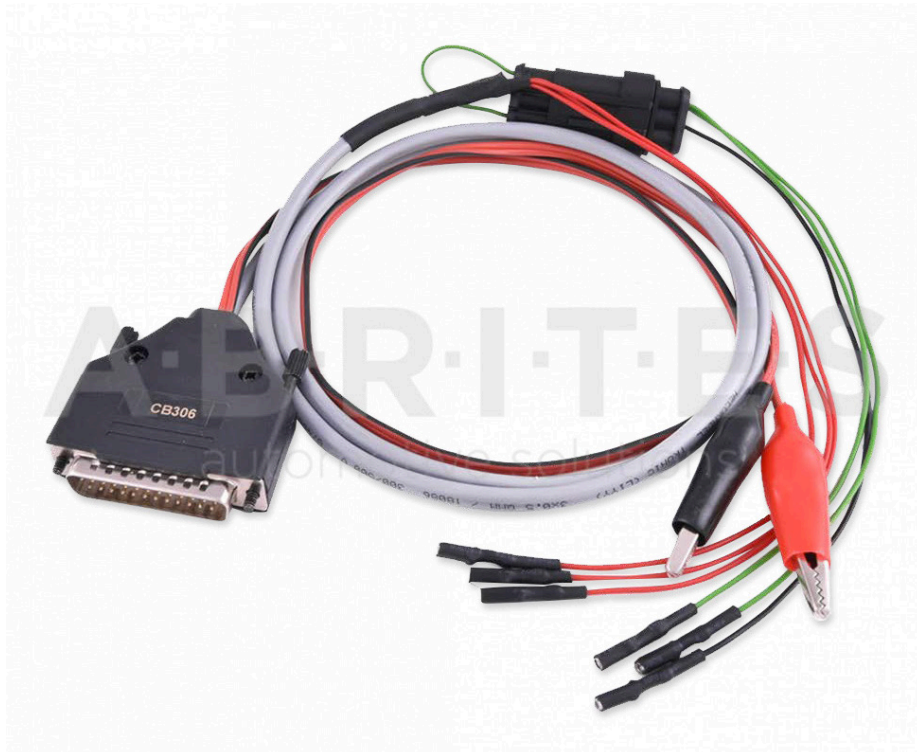

## VII. Appendix

### BMW R1200GS and other CAS4 late model BMW CAS PINs

Before you start the CAS module looks like this and it is covered in gel. Be very careful and remove some of this gel to reveal the EEPROM. Read this with a programmer of your preference and seal again with an appropriate insulating agent to achieve a neat and safe result:



## Harley-Davidson key programming procedure

In order to program a spare key to a Harley-Davidson bikes you need to connect your Abrites CB305 cable to your AVDI (and a J1850 Abrites adapter for the old models with 4-pin connector).

Once the CB305 cable is connected to the OBD connector of the motorcycle open the Abrites Diagnostics for Bikes, Snowmobiles and Water scooters and open the Key learning menu and select "Harley-Davidson":

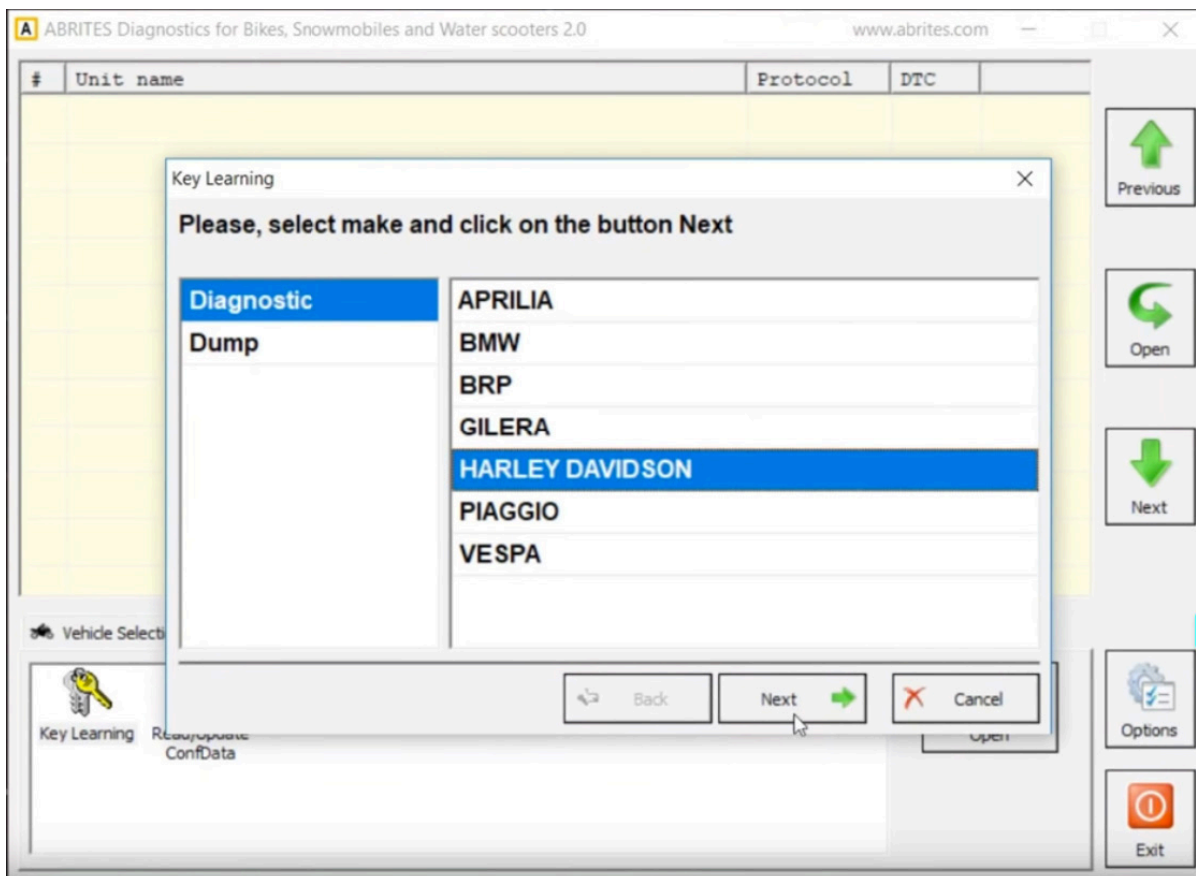

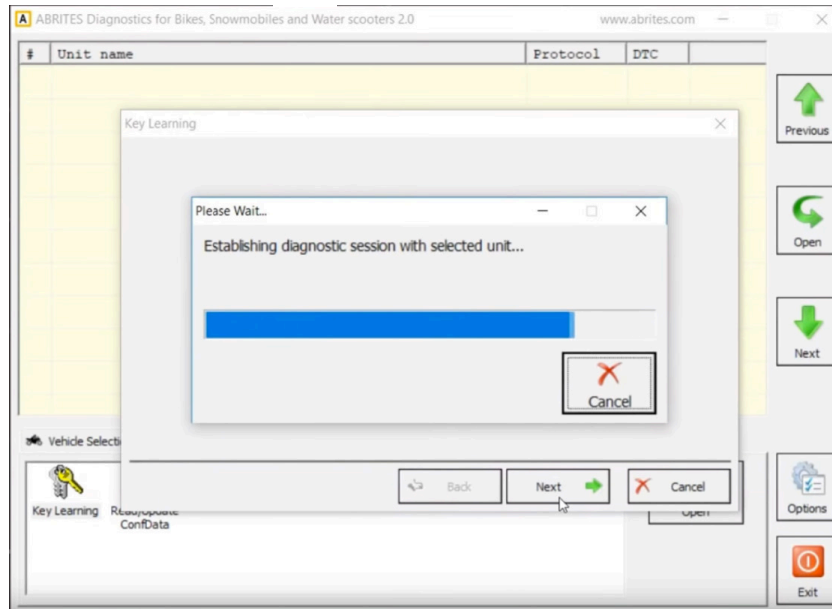

Select the free key position followed by "Next":

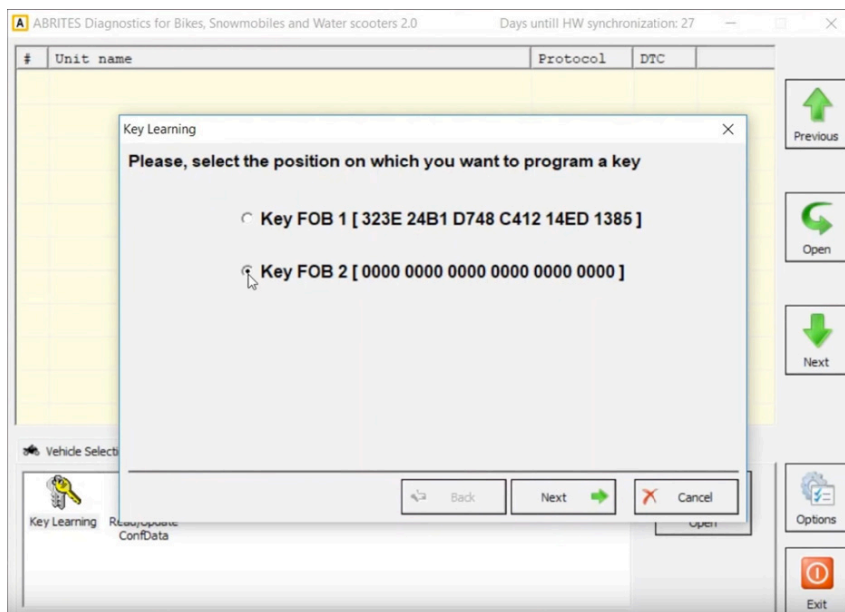

Enter the key FOB Serial Number (it comes with the Harley-Davidson key):

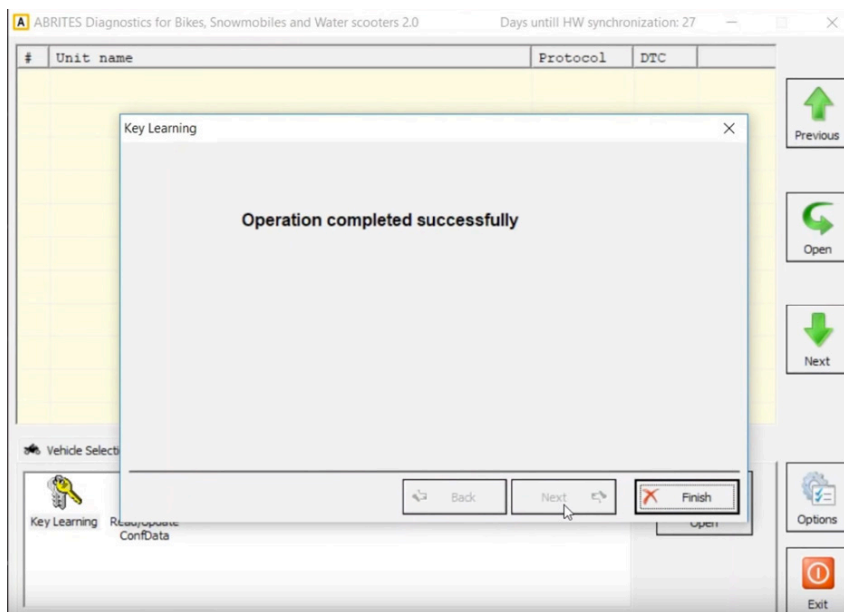
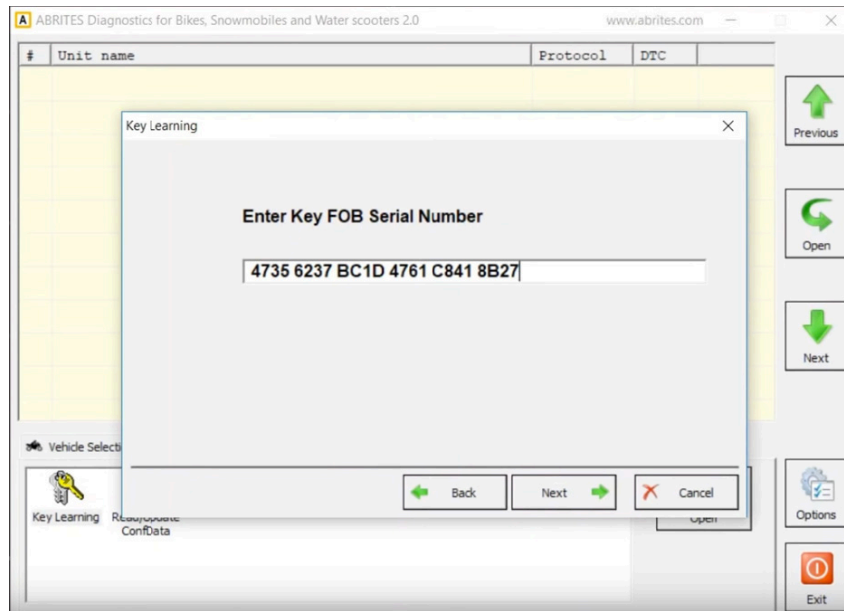

**Note:** In case of all keys lost you need to know the 5-digit PIN code in order to disable the alarm and program a key. The default PIN code you can try with is 1-2-3-4-5.